

Heating and cooling

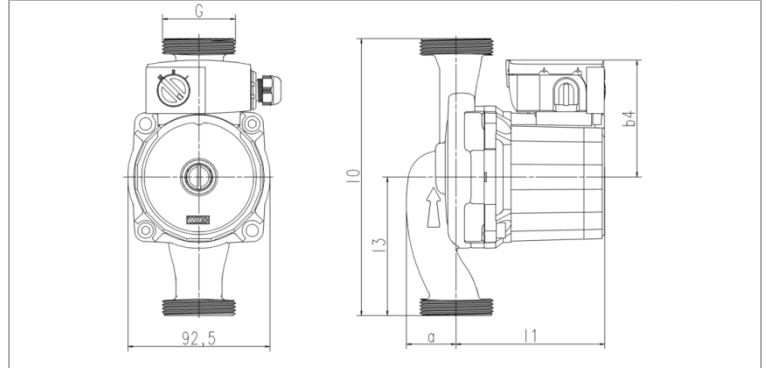

Inline asynchronous circulators for heating application

Type : RS /NY and NX



	Thread	Dimensions				
	G	I0	I3	I1	a	b4
RS15/2 /4 /5 – NY.13 /33 /43 RS15/6 – NY.53 RS15/6 Compact – NY.53 Compact RS15/7 – NY.63	1"	130	65	96,6 96,6 96,6 109,6	28,5	72,5 76 72,5 76
RS20/2 /4 /5 – NY.13 /33 /43 RS20/6 – NY.53 RS20/6 Compact – NY.53 Compact RS20/7 – NY.63	1"1/4	130	65	96,6 96,6 96,6 109,6	28,5	72,5 76 72,5 76
RS25/2 /4 /5 – NY.13 /33 /43 RS25/6 – NY.53 RS25/6 Compact – NY.53 Compact RS25/7 – NY.63	1"1/2	130	65	96,6 96,6 96,6 109,6	33,9	72,5 76 72,5 76
RS25/2 /4 /5 – NY.13 /33 /43 RS25/6 – NY.53 RS25/6 Compact – NY.53 Compact RS25/7 – NY.63	1"1/2	180	90	96,6 96,6 96,6 109,6	33	72,5 76 72,5 76
RS30/2 /4 /5 – NY.13 /33 /43 RS15/6 – NY.53 RS30/6 Compact – NY.53 Compact RS30/7 – NY.63	2"	180	90	96,6 96,6 96,6 109,6	33	72,5 76 72,5 76

Inline asynchronous circulators for heating application

Type : RS /NY and NX

	n 1/m		P1 W	I A	Capacitor µf/VDB
RS../2 NX../13 NY../13	max	1950	48	0,21	1,6 / 400
		1600	31	0,15	
	min	1200	18	0,09	
RS../4 NX../33 NY../33	max	2050	65	0,28	2 / 400
		1650	46	0,20	
	min	1300	30	0,13	
RS../5 NX../43 NY../43	max	2200	88	0,38	2 / 400
		2000	60	0,27	
	min	1600	40	0,18	

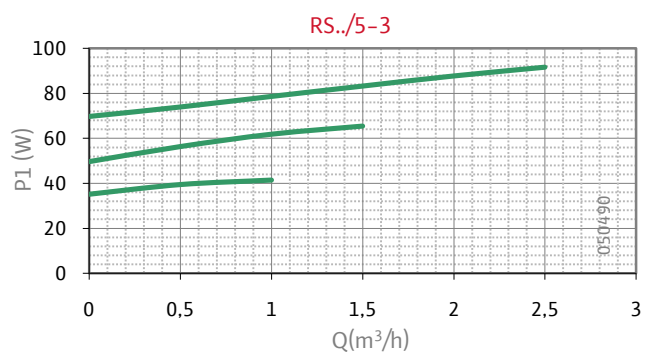
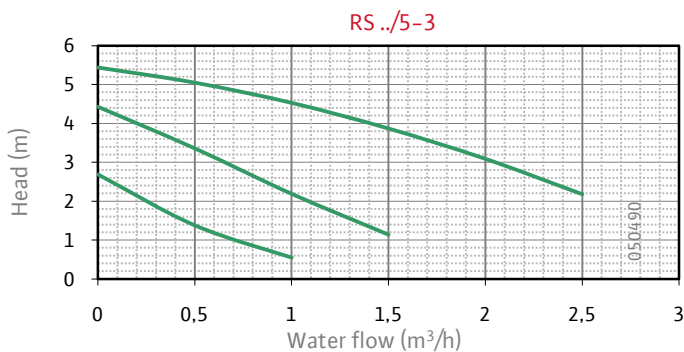
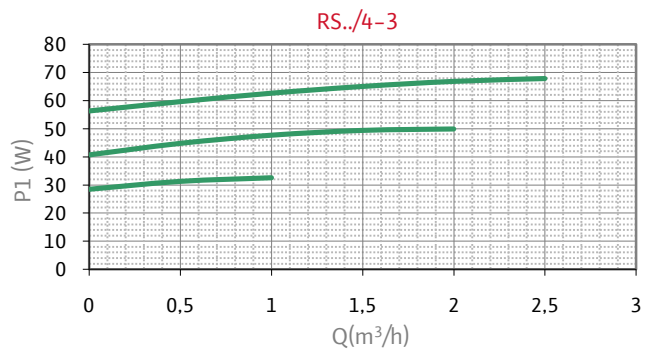
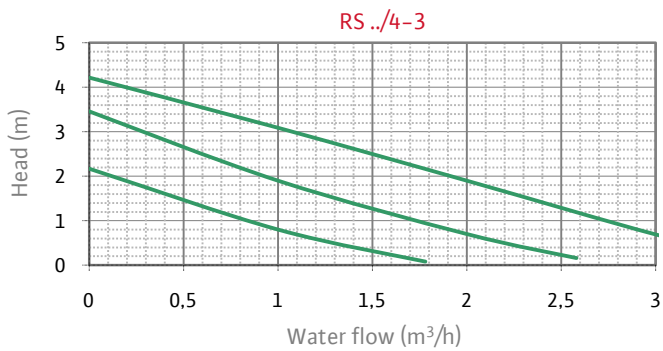
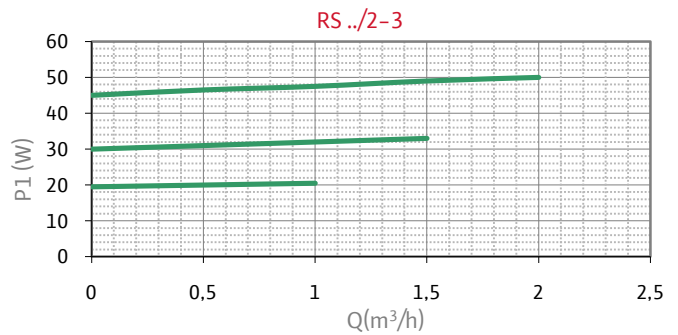
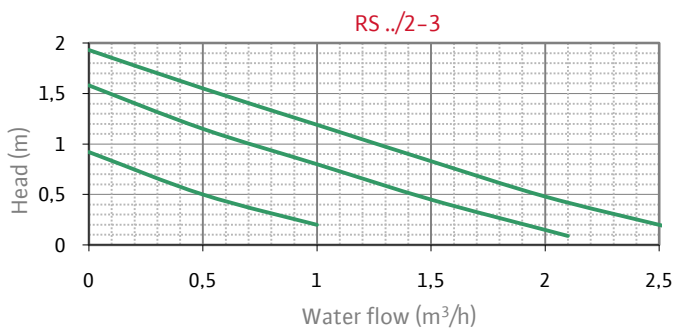

Inline asynchronous circulators for heating application

Type : RS /NY and NX

	n 1/m	P1 W	I A	Capacitor µf /VDB
RS../6 NX../53 NY../53	max	2200	93	2,6 / 400
		1900	67	
	min	1450	46	
RS../6 Compact NX../53 Compact NY../53 Compact	max	2200	91	2 / 400
		1900	58	
	min	1110	36	
RS../7 NX../63 NY../63	max	2450	132	3,5 / 400
		2250	92	
	min	1850	62	

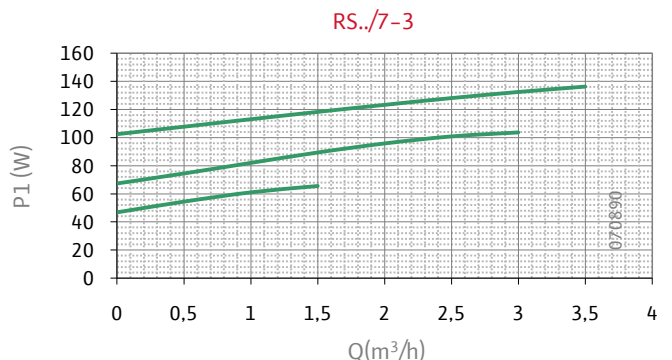
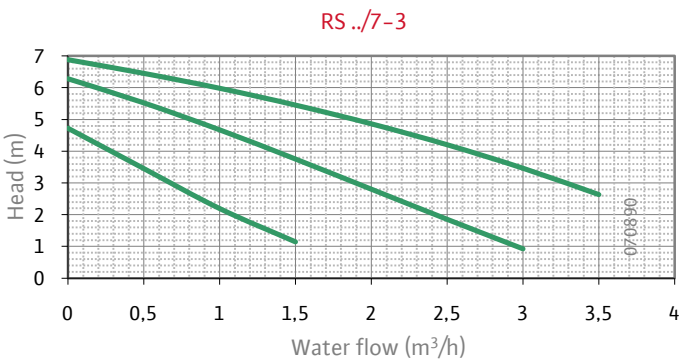
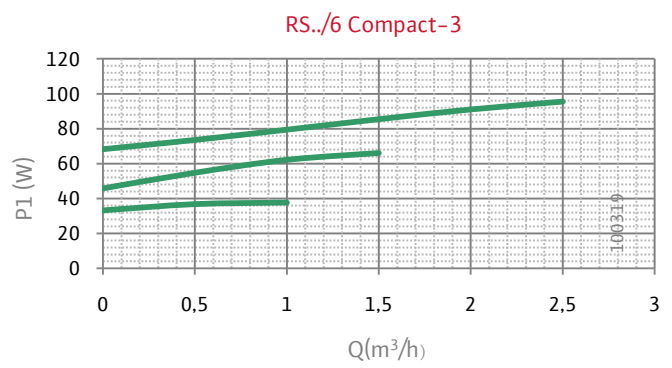
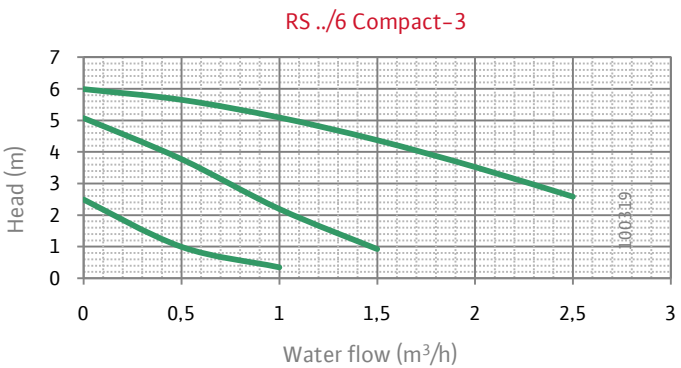
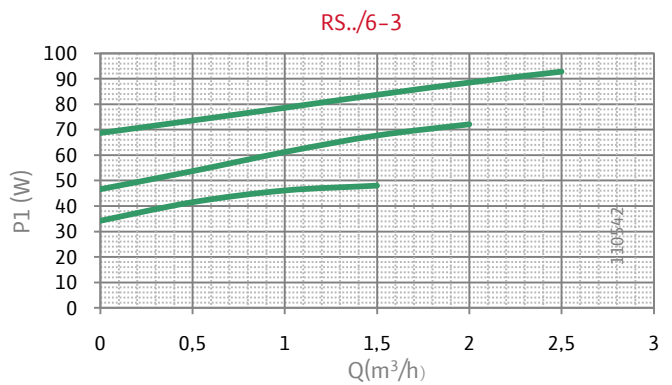
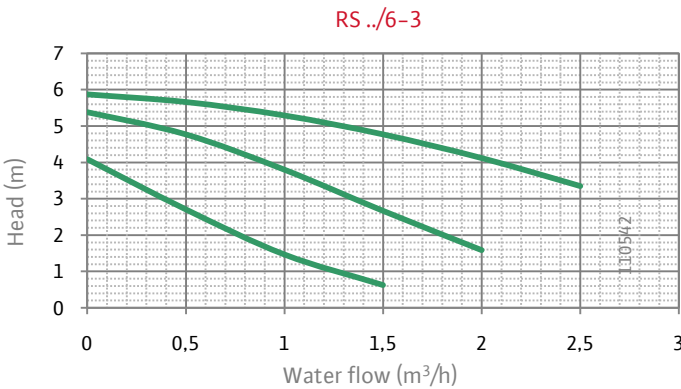

Nota bene : tolerances of each curve are according to EN 1151-1:2006

Wilointec

50 av. Casella
F-18700 Aubigny sur Nère
Tel : +33 2 48 81 62 62
Fax : +33 2 48 58 20 29
www.wilointec.com

information@wilointec.com

Sales & Marketing Director

Vincent Fleurier
Tel : +33 2 48 81 62 74
Fax : +33 2 48 58 20 29
vincent.fleurier@wilointec.com

Sales Administration Manager

Véronique Martin
Tel : +33 2 48 81 62 75
Fax : +33 2 48 58 20 29
veronique.martin@wilointec.com

Sales Manager France & Spain

Robert Carre
Tel : +33 2 48 81 62 72
Fax : +33 2 48 58 20 29
robert.carre@wilointec.com

Sales Manager Italy

Dario Frazza
Tel : +39 335 762 6181
Fax : +39 059 286 0855
dario.frazza@wilointec.com

Sales Manager Subsidiaries

Gilles Moulin
Tel : +33 2 48 81 62 25
Fax : +33 2 48 58 20 29
gilles.moulin@wilointec.com

Sales Manager Germany

Thomas Merscheim
Tel : +49 172 352 3933
Fax : +49 231 410 2578
thomas.merscheim@wilo.de

Sales Manager UK

Kevin Padmore
Tel : +44 776 801 8879
Fax : +44 128 373 2380
kevin.padmore@wilointec.com

Sales Manager Benelux

Ronald Rijkhoff
Tel : +31 653 126 749
Fax : +31 251 215 214
ronald.rijkhoff@wilo.nl